



UnderDuct, Field
Installation Instructions

**MONOXIVENT
FRP
TECHNICAL
INFORMATION**

PROJECT: _____
 LOCATION: _____
 ARCHITECT: _____
 ENGINEER: _____
 SALES ENGINEER: _____
 DATE: _____

www.monoxivent.com

info@monoxivent.com

309-794-1000

Page: 4-13

UNDERDUCT, DRY FIT FIELD JOINT INSTALLATION INSTRUCTIONS

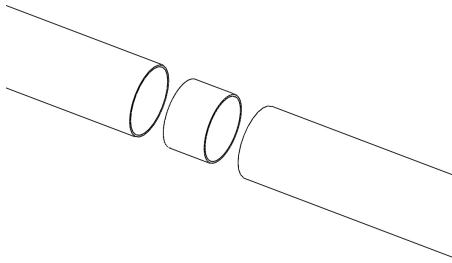

1. The dry installation is joined by putting a 20 gauge split galvanized sheet metal sleeve in between the two butting ducts.

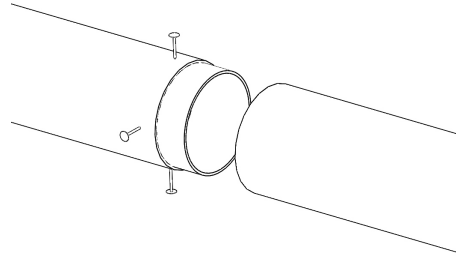

2. The sleeve is put into the first duct along with a UL Listed non-hardening waterproof sealant and screwed into place. The screws are placed two inches (2") away from the end of the duct.

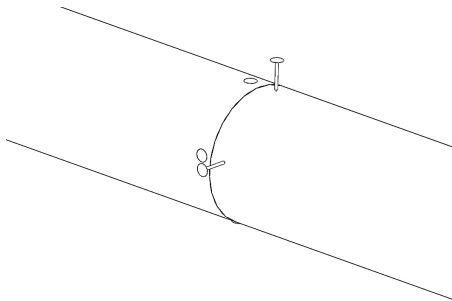

3. The sleeve is then put into the second duct along with duct sealant and screwed into place. The screws are placed 2 inches (2") away from the end of the duct.

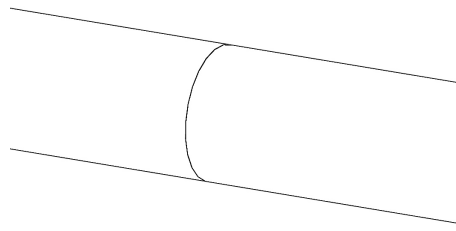

4. Once the ducts and the sleeve are screwed into place, the duct sections should be butted together.

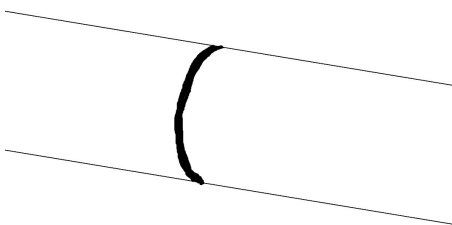

5. A UL Listed non-hardening waterproof duct sealant is added to the gap and the bolt heads. This ensures a tight seal.

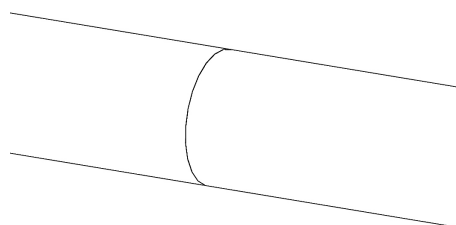

6. After applying the duct sealant, it is then smoothed out to get rid of excess and then left to dry.



UnderDuct, Field
Installation Instructions

**MONOXIVENT
FRP
TECHNICAL
INFORMATION**

PROJECT: _____
LOCATION: _____
ARCHITECT: _____
ENGINEER: _____
SALES ENGINEER: _____
DATE: _____

www.monoxivent.com

info@monoxivent.com

309-794-1000

Page: 4-14

UNDERDUCT, DRY FIT FIELD JOINT INSTALLATION INSTRUCTIONS

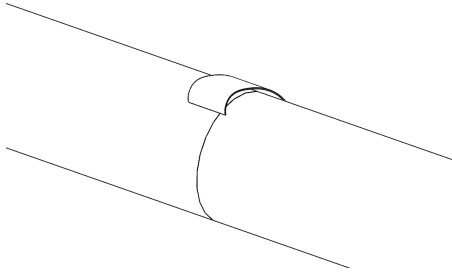

7. After the duct sealant has sufficiently dried, a polyethylene-backed butyl rubber tape is wrapped around the entire joint and screws

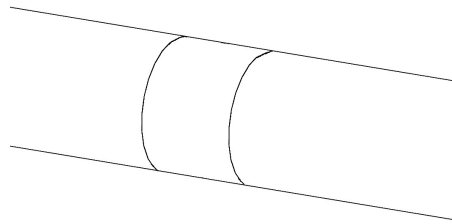

8. The final product is then buried and ready to use.